

M-szériás pneumatikus munkahenger adatlap, M21M3

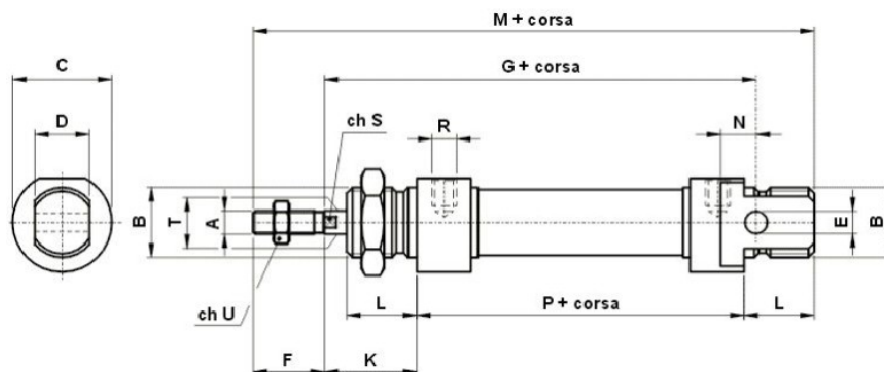

*corsa = lökethossz (mm)

∅	A	B	C	D	E	F	G	K	L	M	N	P	R	S	T	U
10	M4	M12x1.25	∅16	8	∅4	12	64	16	12	86	6	46	M5	-	∅4	7
12	M6	M16x1.5	∅19	12	∅6	16	75	22	18	104	9	48	M5	5	∅6	10
16	M6	M16x1.5	∅19	12	∅6	16	82	22	18	109	9	53	M5	5	∅6	10
20	M8	M22x1.5	∅27	16	∅8	20	95	24	20	131	12	67	G1/8"	7	∅8	13
25	M10x1.25	M22x1.5	∅30	16	∅8	22	104	28	22	140	12	68	G1/8"	9	∅10	17